



## T2050H-8F 20A TRIAC

Rev.A.1.1

### DESCRIPTION:

The T2050H-8F triac is suitable for general purpose AC switching. It can be used as an ON/OFF function in

applications such as heating regulation, induction cookers, motor control, etc.

# T2050H-8F

Average gate power dissipation ( $T_j=150$ )	$P_{G(AV)}$	1	W
Peak gate power	PP A	ä r(T	a

ORDERING INFORMATION

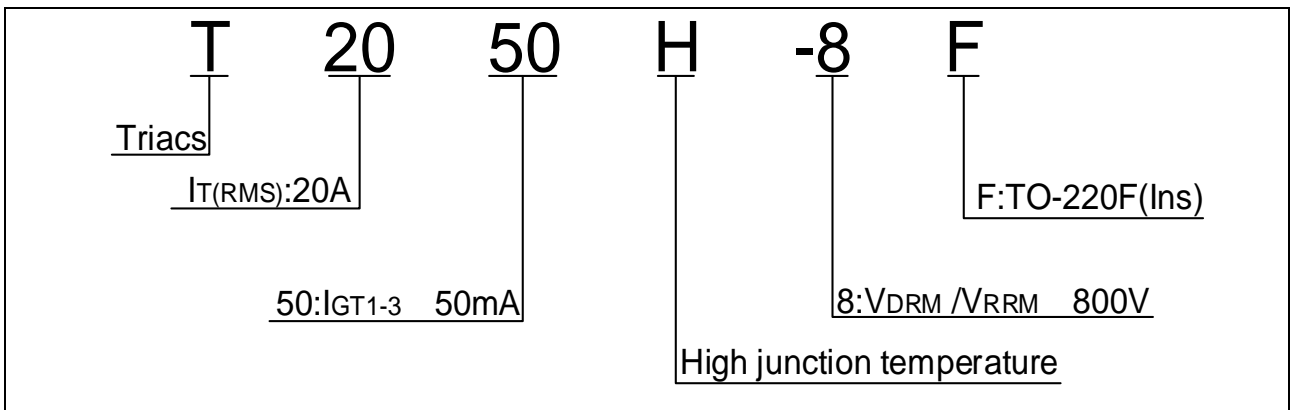

MARKING

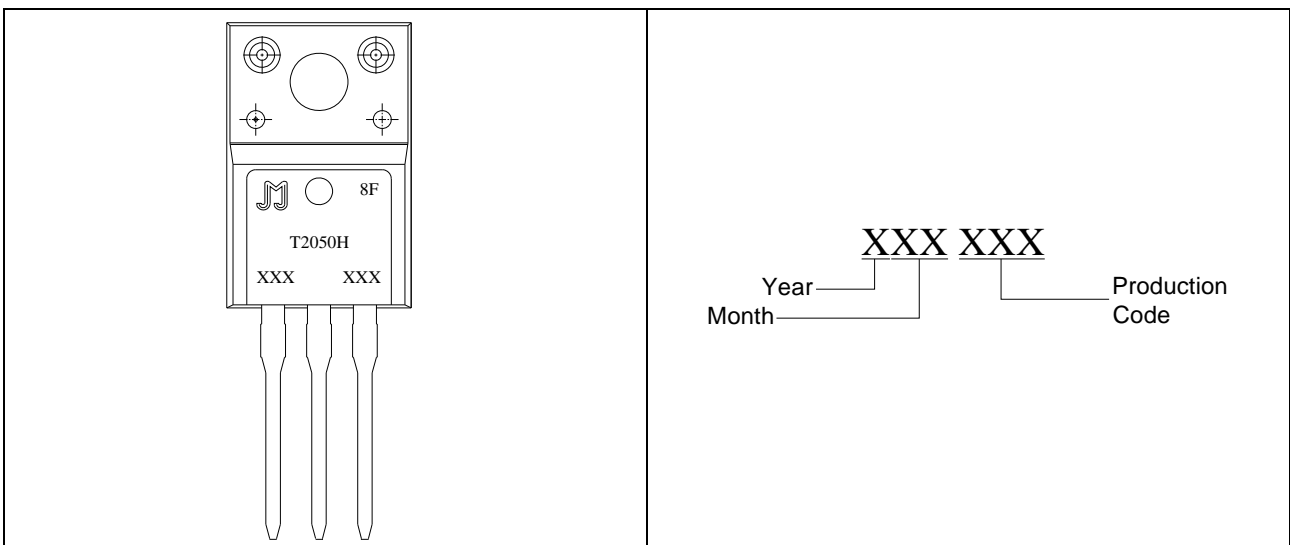

**FIG.1:** Maximum power dissipation versus RMS on-state current

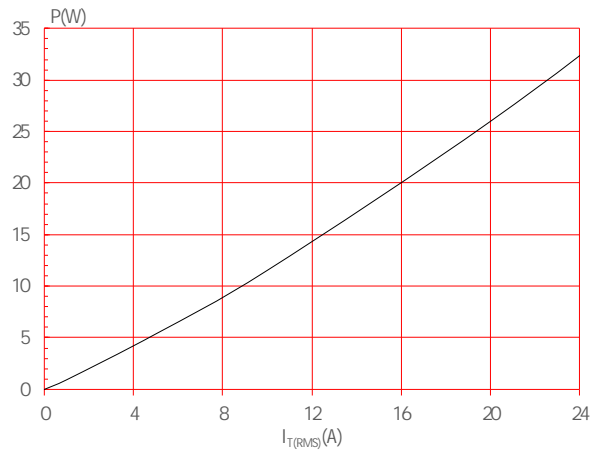

**FIG.2:** RMS on-state current versus case temperature

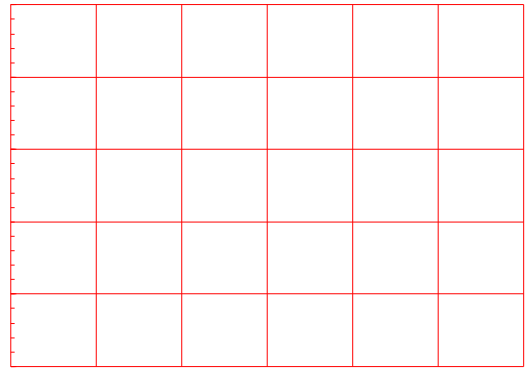
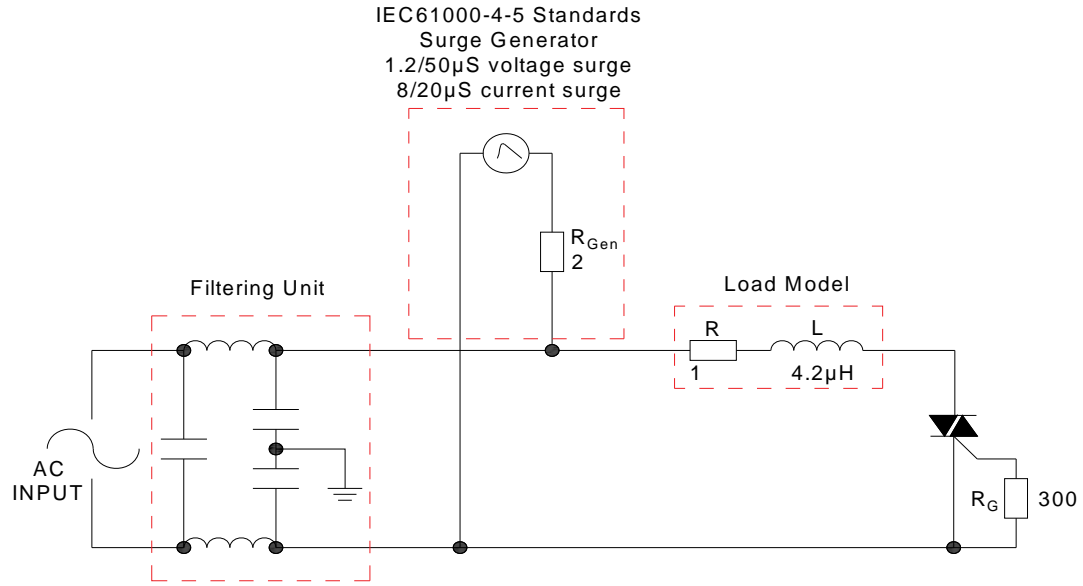

FIG.7 Test circuit for inductive and resistive loads to IEC-61000-4-5 standards



## LEAD FORMING AND SOLDERING

Refer to the application note “Assembly Instructions for Thyristors in Through-hole Package” released by JieJie Microelectronics.

ORDERING INFORMATION

Order code	Voltage V <sub>DRM</sub> /V <sub>RSM</sub> (V)	IGT(mA)	Package	Base qty. (pcs)
------------	---	---------	---------	--------------------

PACKAGE MECHANICAL DATA

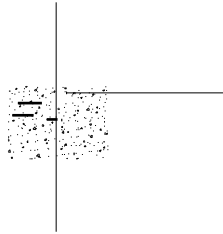

Information furnished in this document is believed to be accurate and reliable. However, Jiangsu JieJie Microelectronics Co., Ltd. assumes no responsibility for the consequences of use without consideration for such information nor use beyond it. Information mentioned in this document is subject to change without notice, apart from that when an agreement is signed, Jiangsu JieJie complies with the agreement.

Products and information provided in this document have no infringement of patents. Jiangsu JieJie assumes no responsibility for any infringement of other rights of third parties which may result from the use of such products and information. This document supersedes and replaces all information previously supplied.

 is a registered trademark of Jiangsu JieJie Microelectronics Co., Ltd.

Copyright © 2025 Jiangsu JieJie Microelectronics Co., Ltd. All rights reserved.