

- 2 & + \$ %



-LH-LH 0LFURHOHFWURQL

^K>hd D y/DhD Z 7H/ESAUDWXUH f &

3DUDPHWHU	6\PERO	9DOXH
-----------	--------	-------

8QL

	,VRODWLRQ 5HVLVWDQFH	5,62	'& 9 a 5 +				
)ORDWLQJ &DSDFLWDQFH	&,2	9 0+]				S)
6ZLWFKLQJ &KDUDFWHULVWLFV	7ULJJHU /(' &XUUHQW	,)7	9&& 9 92 92/				P\$
	3URSDJDWLRQ 'HOD\ 7LPH WR /RJLF /RZ	W+	& S)				QV
	3URSDJDWLRQ 'HOD\ 7LPH WR /RJLF +LJK	W+	5/ P\$				
	3XOVH ZLGWK GLVWRUWLRQ	3W 3W+	,) P\$				QV
	&RPPRQ 0RGH 7UDQVLHQW ,PPXQLW\ DW /RJLF +LJK	&0+	9&& 9 ,) P\$ 9&0 9 5/				N9 V
	&RPPRQ 0RGH 7UDQVLHQW ,PPXQLW\ DW /RJLF /RZ	&0/	9&& 9 ,) P\$ 9&0 9 5/				N9 V
	5LVH 7LPH	WU	& S) 5/ & 6 \$B 6\$ AF , \$ C & € @ 2 @ s d ,) P\$				QV 6@IC'€ X 2 B 0

- 2 & + \$ %

 -LH-LH 0LFURHOHFWURQL

2XWSXW 3XOO XS 5HVLVW/RU				N	
)DQ 2XW/ DW SHU FKDQQHO		1			77/ /RDGV

KZ Z/E' /E&KZD d/KE

<p style="text-align: center;">- 2 & + \$ %</p> <p>-LH-LH 0LFURHOHFWURQLFV & R /WG</p> <p style="text-align: center;">2SWR & RXSOHU</p> <p style="text-align: center;">+LJK VSHHG</p> <p style="text-align: center;">6LQJOH 2&</p> <p style="text-align: right;">9 9&& 9</p>	<p style="text-align: right;">1RQH 7 5 7</p> <p style="text-align: right;">1RQH /623 : /623 :</p> <p style="text-align: center;">P\$</p> <p style="text-align: center;">0%G KLJK VSHHG</p>	%
--	--	---

W I]vP Yμ vš]šÇ	
K% š]]v	Yμ vš]šÇ
E}v IZ	ïïï hv]š•IZ o

D Z</E'



Z Œ š Œ]•š] • μŒÀ •

),* +LJK /HYHO 2XWSXW &XUUHQW),* +LJK /HYHO 2XWSXW &XUUHQW
7HP SHUDWXUH 7HP SHUDWXUH

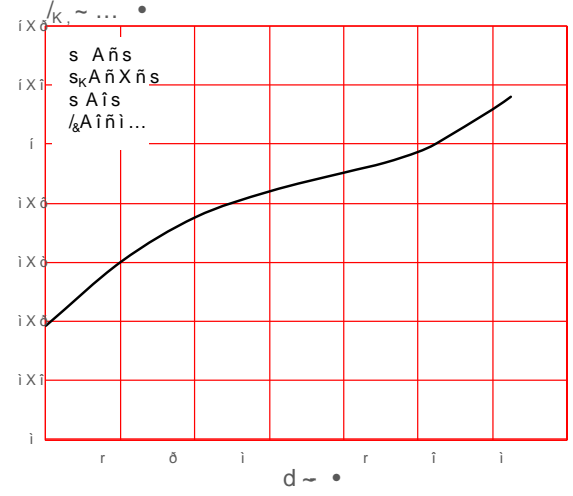
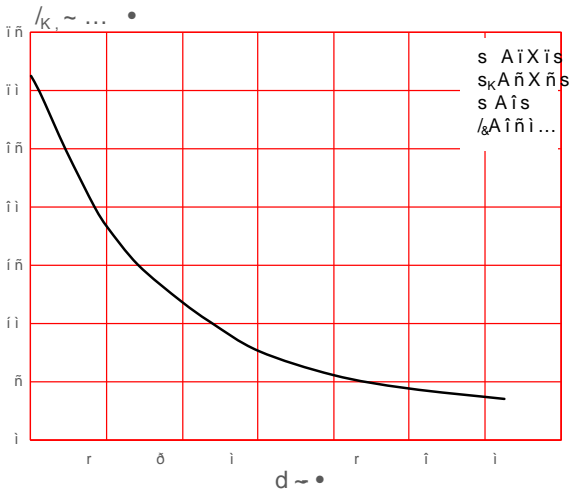

),* ,QSXW 7KUHVCWOG & \$PELHQW),* ,QSXW 7KUHVCWOG & \$PELHQW
7HP SHUDWXUH 7HP SHUDWXUH

Five horizontal red lines for writing.

- 2 & + \$ %

 - LH - LH 0LFURHOHFWURQL

), * /RZ /HYHO 2XWSXW & XUUHQW Y,Y* \$REALHOME • AXWESXW & XUUHQW
7HPSHUDWXUH

- 2 & + \$ %



-LH-LH 0LFURHOHFWURQL

), * 3XOVH :LGWK 'LVWRUWLRQ YV), \$ 3XOVH :LGWK 'LVWRUWLRQ YV), \$
7HPSHUDWXUH 7HPSHUDWXUH

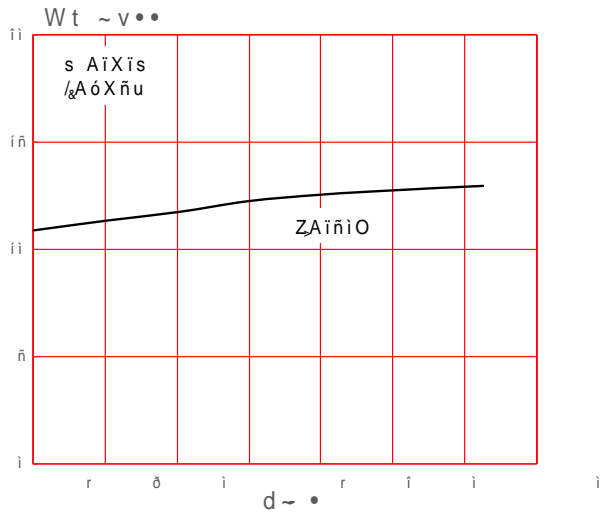

d ^d /Z h/d^

)LJ 6ZLWFKLQJ 7LPH 7HVV &LUFXLW DQG :DYHIRUP

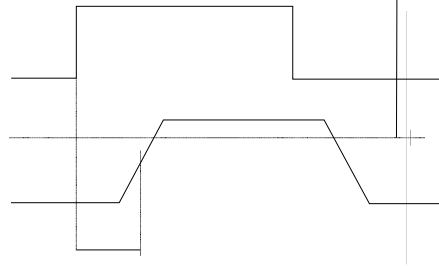
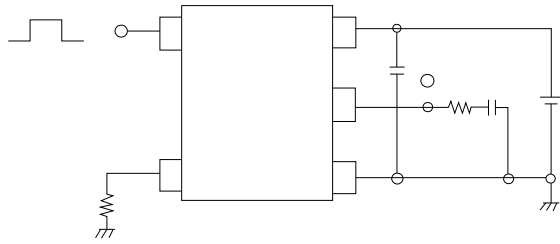

- 2 & + \$ %

W I P]u v •}]v ~hv]šW uu•

> ^KWñ

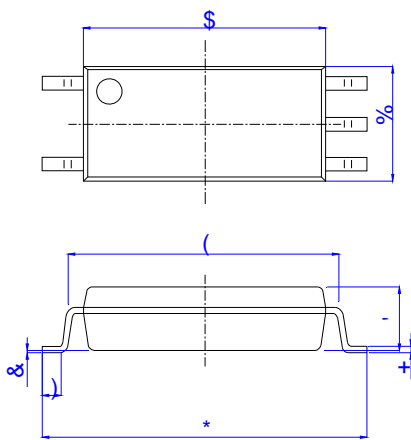

5HI	'LPHQVLRQV					
	0LOOLPHWHUV			,QFKHV		
	0LQ	7\S	0D[0LQ	7\S	0D[
\$						
%						
&						
,						
(
)						
*						
+						
,						
-						
.						

> ^KWñ t

Z KDD E ^K> Z D ^< ~]u v•]}v•]v uu μvσ •• }šZ Œ

> ^KW ñ

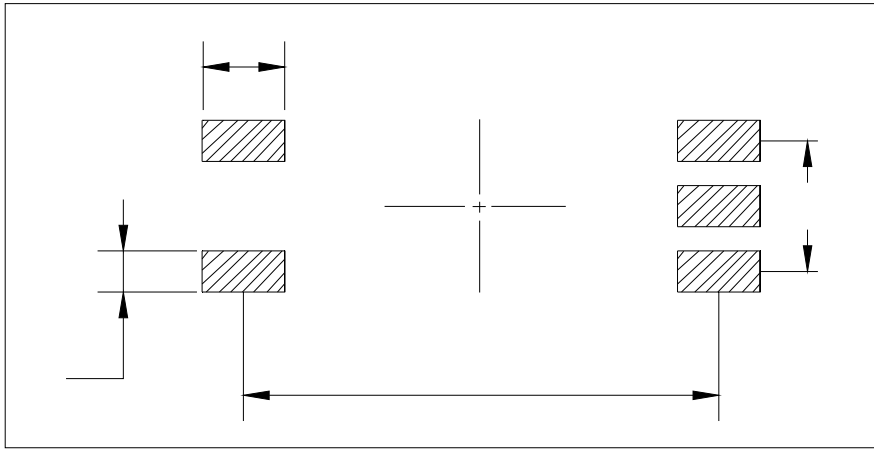

> ^KW ñ t

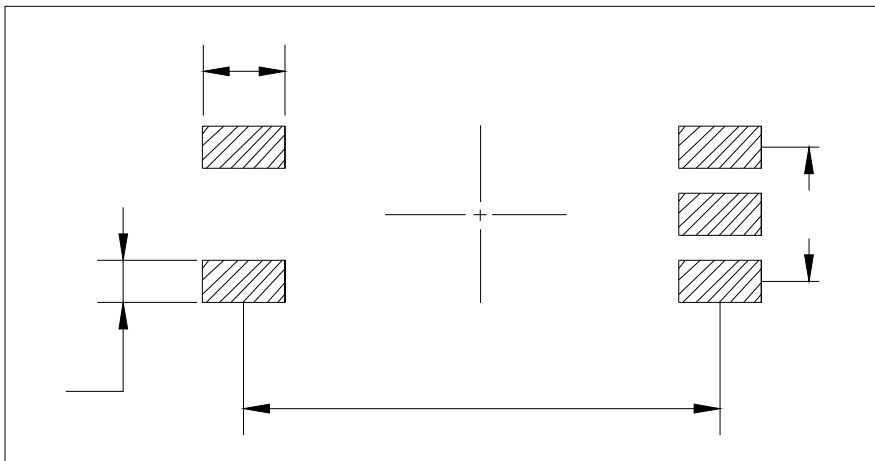

- 2 & + \$ %

M-LH-LH 0LFURHOHFWURQL

ZZ/ Z d W ^W /&/ d/KE }v]uu μνo •••ššž ĆÁ]•

K%o š]}v E}v IZ

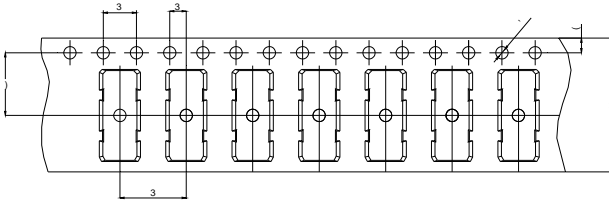

5HI	'LPHQVLRQV					
	0LOOLPHWHUV ,QFKHV					
	0LQ	7\ S	0D[0LQ	7\ S	0D[
'						
3						
3						
3						
(
)						
7						
:						

Z > Kt /E&KZD d/KE

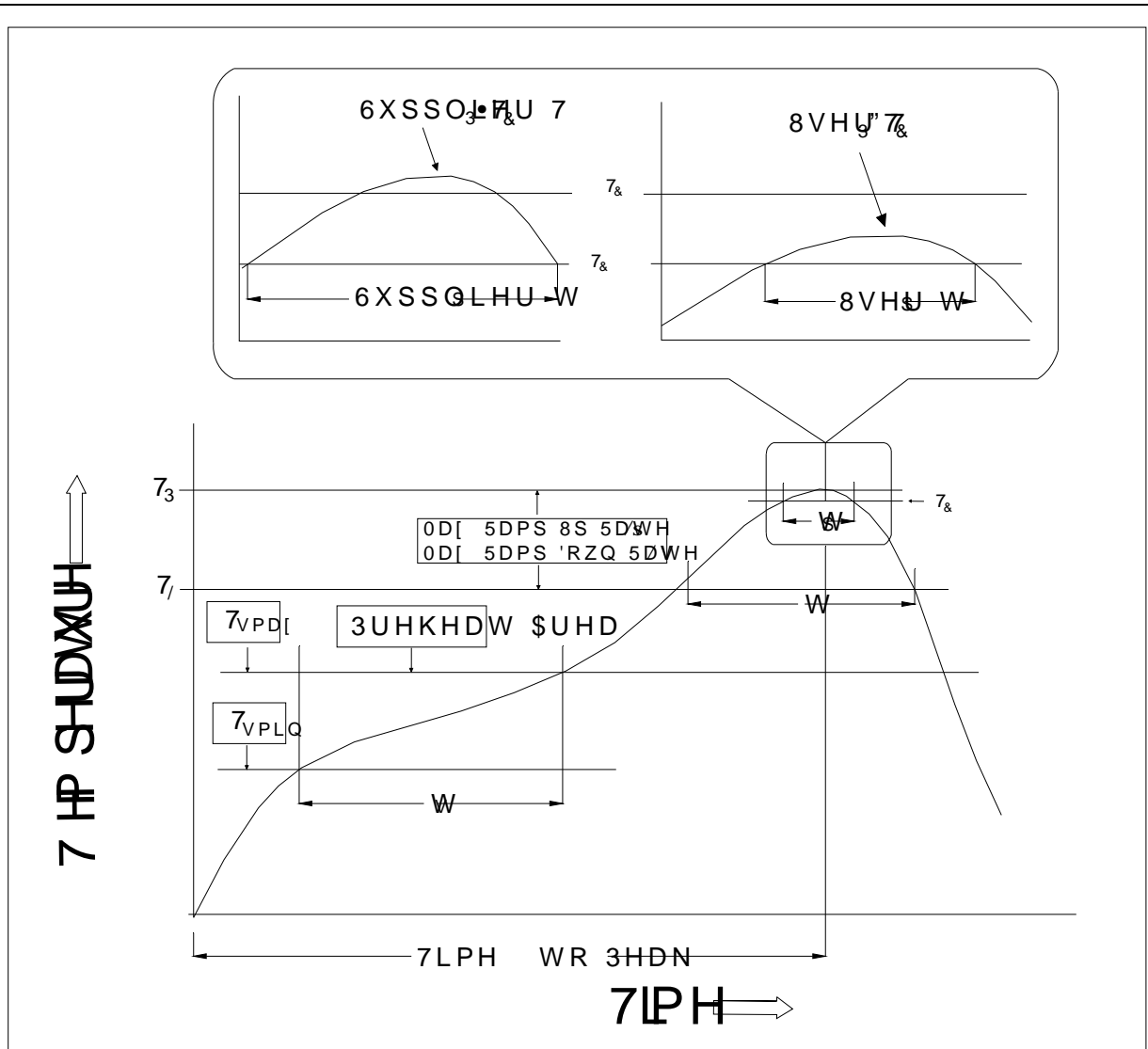

3URILQH)HDWXUH 3E \$VVHPEO\	3URILQH 3E)UHH \$VVH
7HP SHUDWXUH 0LQ 7VPLQ	
7HP SHUDWXUH 0D[7VPD[
7LPH WV IURP 7VPLQ WR 7VPD[VHFRQG V
5DPS XS 5DWH W/ WR W3/HFRQG PD[VHFRQG PD[
/LTXLGXV 7HP SHUDWXUH 7/	
7LPH W/ 0DLQWDLQH \$ERYH 7/	VHFRQG V
3HDN %RG\ 3DFNDJH 7HP SHUDWXUH	
7LPH W3 ZLWIKLQ	VHFRQG V
5DPS GRZQ 5DWH 73 WR 7/HFRQG PD[VHFRQG PD[
7LPH WR 3HDN 7HP SHUDWXUH	PLQXWHV PD[

1RWH

- 2 & + \$ %



- LH - LH 0LFURHOHFWURQL

5HIORZ VROGHULQJ LV UHFRPPHQGHG/ DWRZKH QHPSWKUDWHDWHDVHDV
\$YRLG GLUHFV FRQVHDIFSRPHFRZDQWRXUDFRU/ H[FHHGLQJ LWV PD
VWRUDJH WHPSHUDWXUH

\$SSOLFDFWLRQ RKHSHRYXENRQLWLSOHGDDWHG WHPSHUDWXUHV ,Q V
VFHQDULRV DQHPSVOLHGRWRHFFHHG 1

(QVXUH WKH FRPSRQHQW KDV FRROHG WRDFHEWKDQZLXPSVHDXHQL
PDQXIDFWXULQJ VWHSV

7KH FRPSRQHQW KDM BQMKHDDUQZKHQVWRDGHGKFRQLGLWLRQV

5HFRPPHQG VWRUDJH 7HPS a f&

5HFRPPHQG VWRUDJH KXPLGLW\

06/ OHYHO 06/

,QIRUPDWLRQ IXUQXPHQW/ LQ WKOLHGRHG WR EH DFFXUDWH D
-LDQJVVX -LH-LH 0LFRHOHWHG WDRVQLFFVVQLRV UHRV RQVHLERQVHT
RI XVH ZLWKRXW FRQVLGHUDWLRQ IRG MWFKQIQURPDVWRQRQ
LQ WKLV GRFXPHQW LQJYXZLWHEFRXWRQRWLFH DSDUW IURP V
VLJQHGH -LDQJVSOLHVLZILFRKPKKH DJUHHPHQW

3URGXFVV DQG LQIRUPDWLRQ SURYLGHG LQ HQWVHGSDXPH
-LDQJVVX -LH-LH DVVXPHLOQR\URVSRQVLQIULQJHPPHQW RI RW
ZKLFK PD\ UHVXOW IURP WKH XVH RI VFKLW SURFXPHQW DQGS HL
DQG UHSODFHV DOO LQIRUPDWLRQ SUHYLRXVO\ VXSSOLHG



LV D UHJLVWHUHGDQJDXGLFDUNRUFURHOHFWWURQLFV & R
&RS\ULJKW -LDQJVVX -LH-LH 0LFURHOHFWUSPQDGLJKWV UHVH

'RFXPHQW 5HJLVLRQ +LVWRU\