



### Product Summary

- Ultra-low  $R_{DS(ON)}$
- Low Gate Charge
- 100% UIS Tested, 100%  $R_g$  Tested
- Pb-free Lead Plating
- Halogen-free and RoHS-compliant

	Value	Unit
	60	V
	1.7	V
I	10	A
	7.0	m
	9.5	m

- Power Management in Computing, CE, IE 4.0, Communications
- Current Switching in DC/DC & AC/DC (SR) Sub-systems
- Load Switching, Quick/Wireless Charging, Motor Driving

	Package	# of Pins	Marking	MSL	$T_J$ (°C)	Media	Quantity (pcs)
JMSL0609APD-13	SOP-8L	8	SL0609AD	3	-55 to 150	13-inch Reel	2500

### Absolute Maximum Ratings (@ $T_A = 25^\circ\text{C}$ unless otherwise specified)

Parameter	Symbol	Value	Unit
Drain-to-Source Voltage	$V_{DS}$	60	V
Gate-to-Source Voltage	$V_{GS}$	$\pm 20$	V
Continuous Drain Current <sup>(1)</sup>	$I_D$	$T_A = 25^\circ\text{C}$	10
		$T_A = 70^\circ\text{C}$	8
Pulsed Drain Current <sup>(2)</sup>	$I_{DM}$	40	A
Avalanche Current <sup>(3)</sup>	$I_{AS}$	24	A
Avalanche Energy <sup>(3)</sup>	$E_{AS}$	29	mJ
Power Dissipation <sup>(4)</sup>	$P_D$	$T_A = 25^\circ\text{C}$	1.7
		$T_A = 70^\circ\text{C}$	1.1
Junction & Storage Temperature Range	$T_J, T_{STG}$	-55 to 150	°C

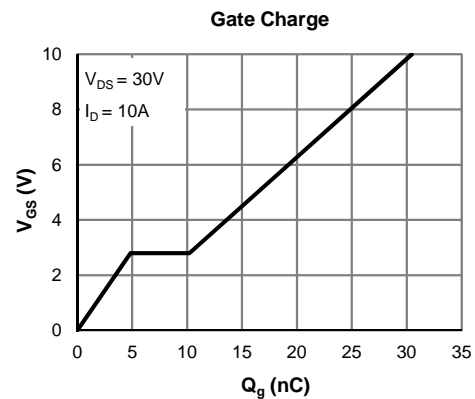
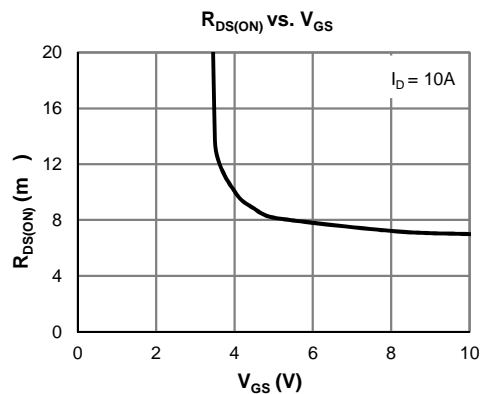



**Electrical Characteristics** (@  $T_J = 25^\circ\text{C}$  unless otherwise specified)

Parameter	Symbol	Conditions	Min.	Typ.	Max.	Unit
<b>STATIC PARAMETERS</b>						
Drain-Source Breakdown Voltage	$V_{(BR)DSS}$	$I_D = 250\text{ A}, V_{GS} = 0\text{V}$	60			V
Zero Gate Voltage Drain Current	$I_{DSS}$	$V_{DS} = 48\text{V}, V_{GS} = 0\text{V}$			1.0	A
					5.0	
Gate-Body Leakage Current	$I_{GSS}$	$V_{DS} = 0\text{V}, V_{GS} = \pm 20\text{V}$			$\pm 100$	nA
Gate Threshold Voltage	$V_{GS(th)}$	$V_{DS} = V_{GS}, I_D = 250\text{ A}$	1.2	1.7	2.5	V
Static Drain-Source ON-Resistance	$R_{DS(on)}$	$V_{GS} = 10\text{V}, I_D = 10\text{A}$		7.0	9.2	m
	$R_{DS(on)}$	$V_{GS} = 4.5\text{V}, I_D = 8.5\text{A}$		9.5	12.5	m
Forward Transconductance	$g_{FS}$	$V_{DS} = 5\text{V}, I_D = 10\text{A}$		85		S
Diode Forward Voltage	$V_{SD}$	$I_S = 1\text{A}, V_{GS} = 0\text{V}$		0.71	1.0	V
Diode Continuous Current	$I_S$	$T_C = 25^\circ\text{C}$			2	A
<b>DYNAMIC PARAMETERS <sup>(5)</sup></b>						
Input Capacitance	$C_{iss}$	$V_{GS} = 0\text{V}, V_{DS} = 30\text{V}, f = 1\text{MHz}$		2122		pF
Output Capacitance	$C_{oss}$			440		pF
Reverse Transfer Capacitance	$C_{rss}$			4.4		pF
Gate Resistance	$R_g$	$V_{GS} = 0\text{V}, V_{DS} = 0\text{V}, f = 1\text{MHz}$		1.4		
<b>SWITCHING PARAMETERS <sup>(5)</sup></b>						
Total Gate Charge (@ $V_{GS} = 10\text{V}$ )	$Q_g$	$V_{GS} = 0\text{ to }10\text{V}$ $V_{DS} = 30\text{V}, I_D = 10\text{A}$		31		nC
Total Gate Charge (@ $V_{GS} = 4.5\text{V}$ )	$Q_g$			14		nC
Gate Source Charge	$Q_{gs}$			4.8		nC
Gate Drain Charge	$Q_{gd}$			5.4		nC
Turn-On Delay Time	$t_{D(on)}$	$V_{GS} = 10\text{V}, V_{DS} = 30\text{V}$ $R_L = 3\ \Omega, R_{GEN} = 6\ \Omega$		8.0		ns
Turn-On Rise Time	$t_r$			5.1		ns
Turn-Off Delay Time	$t_{D(off)}$			38		ns
Turn-Off Fall Time	$t_f$			14.8		ns
Body Diode Reverse Recovery Time	$t_{rr}$	$I_F = 10\text{A}, di_F/dt = 100\text{A}/\text{s}$		37		ns
Body Diode Reverse Recovery Charge	$Q_{rr}$	$I_F = 10\text{A}, di_F/dt = 100\text{A}/\text{s}$		43		nC

**Thermal Performance**

Parameter	Symbol	Typ.	Max.	Unit
Thermal Resistance, Junction-to-Ambient (t 10s)	$R_{JA}$	60	75	$^\circ\text{C}/\text{W}$
Thermal Resistance, Junction-to-Ambient (steady state)	$R_{JA}$	100	120	$^\circ\text{C}/\text{W}$

**Notes:**

1. Computed continuous current assumes the condition of  $T_{J\_Max}$  while the actual continuous current depends on the thermal & electro-mechanical application board design.
2. This single-pulse measurement was taken under  $T_{J\_Max} = 150^\circ\text{C}$ .
3. This single-pulse measurement was taken under the following condition [ $L = 100\ \text{H}, V_{GS} = 10\text{V}, V_{DS} = 30\text{V}$ ] while its value is limited by  $T_{J\_Max} = 150^\circ\text{C}$ .
4. The power dissipation  $P_D$  is based on  $T_{J\_Max} = 150^\circ\text{C}$ .
5. This value is guaranteed by design hence it is not included in the production test.

Typical Electrical & Thermal Characteristics

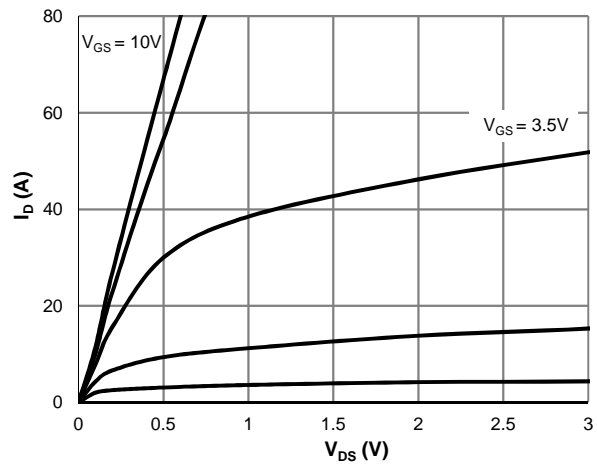
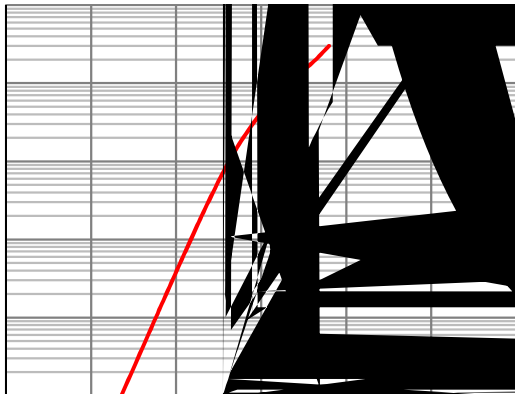

Figure 1: Saturation Characteristics





### Typical Electrical & Thermal Characteristics

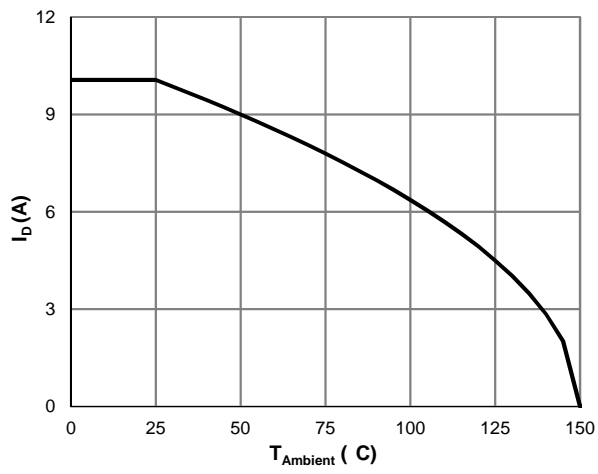

Figure 7: Current De-rating

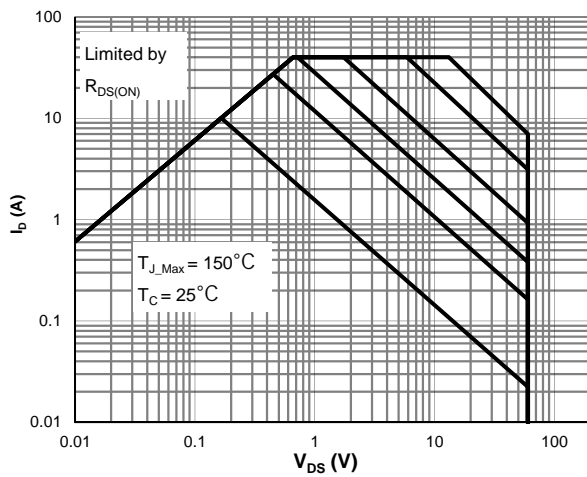
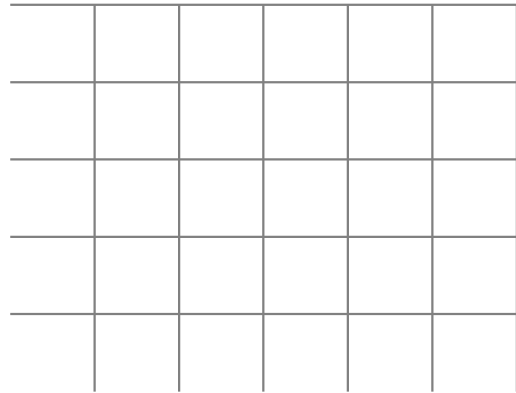
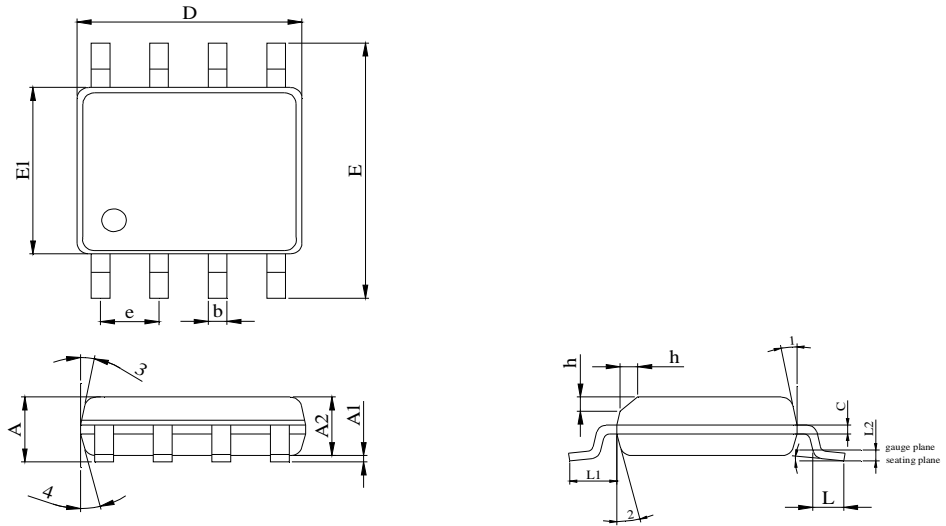

Figure 9: Maximum Safe Operating Area



SOP-8L Package Information

Package Outline



DIM	MILLIMETER		
	MIN.	NOM.	MAX.
A	1.35	1.50	1.65
A1	0.05	0.10	0.15
A2	1.35	1.40	1.50
b	0.38	--	0.50
c	0.17	--	0.25
D	4.80	4.90	5.00
E	5.80	6.00	6.20
E1	3.80	3.90	4.00

Recommend Soldering Footprint

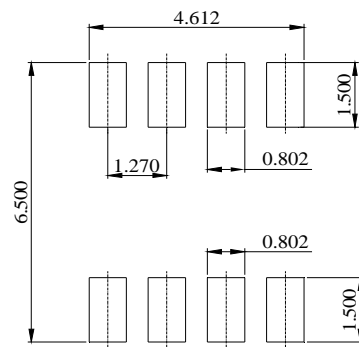

DIMENSIONS: MILLIMETERS